

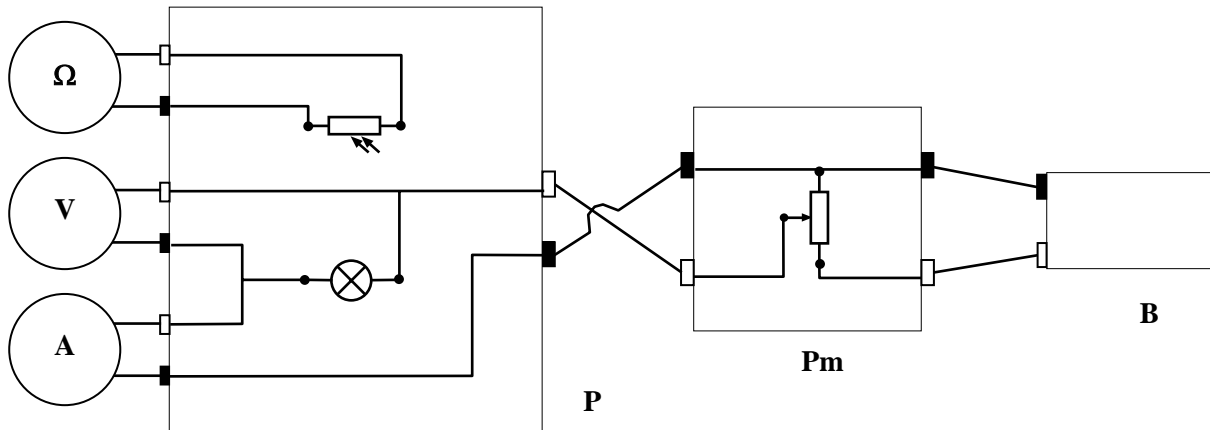



PLANCK'S CONSTANT IN THE LIGHT OF AN INCANDESCENT LAMP SOLUTION

TASK 1

Draw the electric connections in the boxes and between boxes below.

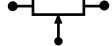

Photoresistor	
Incandescent Bulb	
Potentiometer	
Red socket	
Black socket	

Ω	Ohmmeter
V	Voltmeter
A	Ammeter
P	Platform
Pm	Potentiometer
B	Battery

TASK 2

a)

$t_0 = 24\text{ }^\circ\text{C}$	$T_0 = 297\text{ K}$	$\Delta T_0 = 1\text{ K}$
----------------------------------	----------------------	---------------------------

b)

V/mV	I/mA	R_B/Ω
21.9	1.87	11.71
30.5	2.58	11.82
34.9	2.95	11.83
37.0	3.12	11.86
40.1	3.37	11.90
43.0	3.60	11.94
47.6	3.97	11.99
51.1	4.24	12.05
55.3	4.56	12.13
58.3	4.79	12.17
61.3	5.02	12.21
65.5	5.33	12.29
67.5	5.47	12.34
73.0	5.88	12.41
80.9	6.42	12.60
85.6	6.73	12.72
89.0	6.96	12.79
95.1	7.36	12.92
111.9	8.38	13.35
130.2	9.37	13.89
181.8	11.67	15.63
220	13.04	16.87
307	15.29	20.08
447	17.68	25.28
590	19.8	29.80
730	21.5	33.95
860	23.2	37.07
960	24.4	39.34

$$V_{\min} = 9.2\text{ mV}$$

*

* This is a characteristic of your apparatus. You can't go below it.

 We represent R_B in the vertical axis against I .

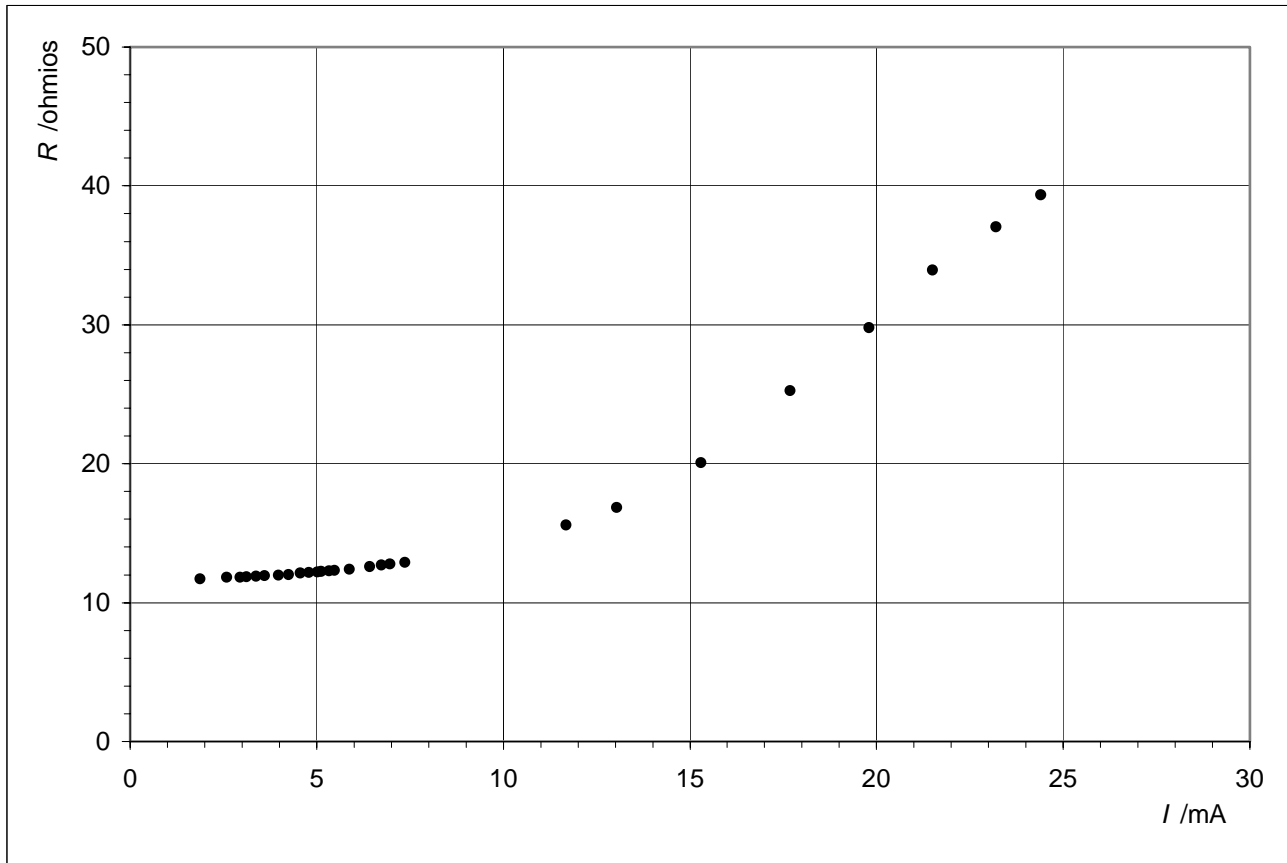

In order to work out R_{B0} , we choose the first ten readings.

TASK 2

c)

V / mV	I / mA	R_B / Ω
21.9 ± 0.1	1.87 ± 0.01	11.71 ± 0.08
30.5 ± 0.1	2.58 ± 0.01	11.82 ± 0.06
34.9 ± 0.1	2.95 ± 0.01	11.83 ± 0.05
37.0 ± 0.1	3.12 ± 0.01	11.86 ± 0.05
40.1 ± 0.1	3.37 ± 0.01	11.90 ± 0.05
43.0 ± 0.1	3.60 ± 0.01	11.94 ± 0.04
47.6 ± 0.1	3.97 ± 0.01	11.99 ± 0.04
51.1 ± 0.1	4.24 ± 0.01	12.05 ± 0.04
55.3 ± 0.1	4.56 ± 0.01	12.13 ± 0.03
58.3 ± 0.1	4.79 ± 0.01	12.17 ± 0.03

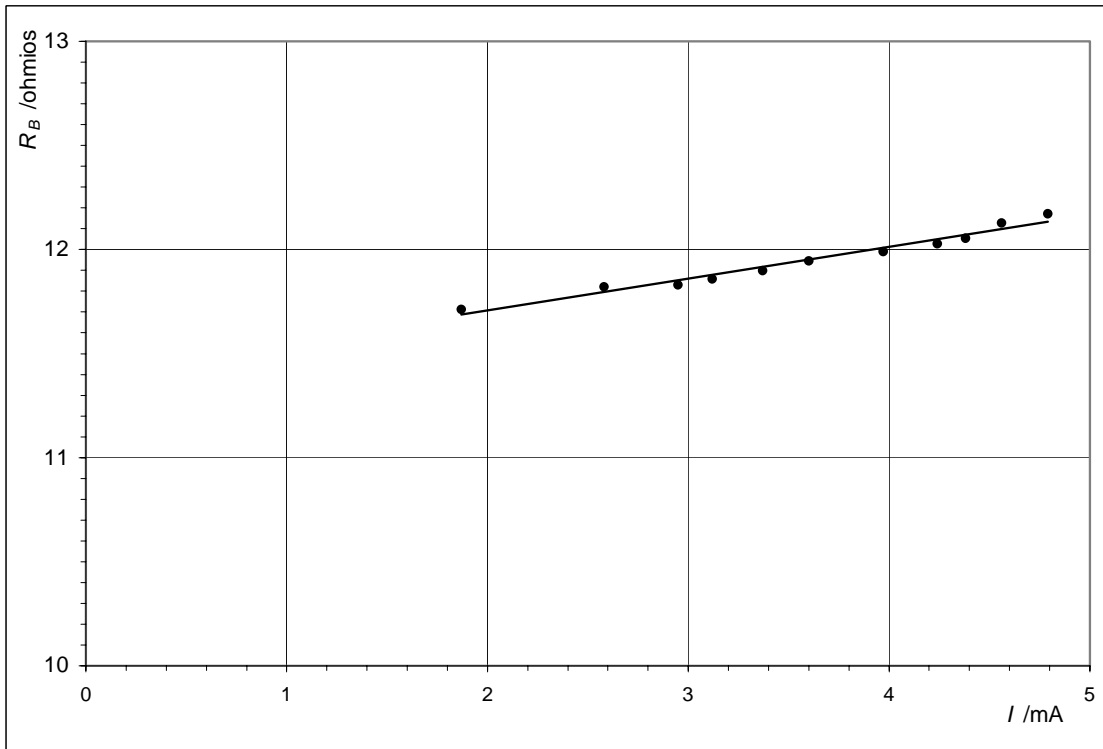

Error for R_B (We work out the error for first value, as example).

$$\Delta R_B = R_B \sqrt{\left(\frac{\Delta V}{V}\right)^2 + \left(\frac{\Delta I}{I}\right)^2} = 11.71 \sqrt{\left(\frac{0.1}{21.9}\right)^2 + \left(\frac{0.01}{1.87}\right)^2} = 0.08$$

We have worked out R_{B0} by the least squares.

$$R_{B0} = 11.39$$

$$\text{slope} = m = 0.157$$

$$\sum I^2 = 130.38$$

$$\sum I = 35.05$$

$$n = 10$$

$$\text{For axis } X : \sigma_I = \frac{\sum \Delta I}{n} = 0.01$$

$$\text{For axis } Y : \sigma_{R_B} = \frac{\sum \Delta R_B}{n} = 0.047$$

$$\sigma = \sqrt{\sigma_{R_B}^2 + m^2 \sigma_I^2} = \sqrt{0.047^2 + 0.157^2 \cdot 0.01^2} = 0.047$$

$$\Delta R_{B0} = \sqrt{\frac{\sigma^2 \sum I^2}{n \sum I^2 - (\sum I)^2}} = \sqrt{\frac{0.047^2 \times 130.38}{10 \cdot 130.38 - 35.05^2}} = 0.06$$

$R_{B0} = 11,39 \Omega$	$\Delta R_{B0} = 0.06 \Omega$
-------------------------	-------------------------------

$$d) \quad T = aR^{0.83} ; \quad a = \frac{T_0}{R_0^{0.83}} ; \quad a = \frac{297}{11.39^{0.83}} = 39.43$$

Working out the error for two methods:

Method A

$$\ln a = \ln T_0 - 0.83 \ln R_{B0} ; \quad \Delta a = a \left(\frac{\Delta T_0}{T_0} + 0.83 \frac{\Delta R_{B0}}{R_{B0}} \right) ; \quad \Delta a = 39.43 \left(\frac{1}{297} + 0.83 \frac{0.06}{11.39} \right) = 0.305 = 0.3$$

Method B

$$\text{Higher value of } a: \quad a_{\max} = \frac{T_0 + \Delta T_0}{(R_0 - \Delta R_0)^{0.83}} = \frac{297 + 1}{(11.39 - 0.06)^{0.83}} = 39.7379$$

$$\text{Smaller value of } a: \quad a_{\min} = \frac{T_0 - \Delta T_0}{(R_0 + \Delta R_0)^{0.83}} = \frac{297 - 1}{(11.39 + 0.06)^{0.83}} = 39.1276$$

$$\Delta a = \frac{a_{\max} - a_{\min}}{2} = \frac{39.7379 - 39.1276}{2} = 0.305 = 0.3$$

$a = 39.4$	$\Delta a = 0.3$
------------	------------------

TASK 3

Because of $2\Delta\lambda = 620 - 565$; $\Delta\lambda = 28$ nm

$\lambda_0 = 590$ nm	$\Delta\lambda = 28$ nm
----------------------	-------------------------

TASK 4

a)

V/V	I/mA	$R/k\Omega$
9.48	85.5	8.77
9.73	86.8	8.11
9.83	87.3	7.90
100.1	88.2	7.49
10.25	89.4	7.00
10.41	90.2	6.67
10.61	91.2	6.35
10.72	91.8	6.16
10.82	92.2	6.01
10.97	93.0	5.77
11.03	93.3	5.69
11.27	94.5	5.35
11.42	95.1	5.17
11.50	95.5	5.07

b)

$$\text{Because of } \ln \frac{R}{R'} = \gamma \ln 0.512 ; \quad \gamma = \ln \frac{R}{R'} / \ln 0.512 = \ln \frac{5.07}{8.11} / \ln 0.512 = 0.702$$

 For working out $\Delta\gamma$ we know that:

$$R \pm \Delta R = 5.07 \pm 0.01 \text{ k}\Omega$$

$$R' \pm \Delta R' = 8.11 \pm 0.01 \text{ k}\Omega$$

$$\text{Transmittance, } t = 51.2 \%$$

Working out the error for two methods:

Method A

$$\gamma = \frac{\ln R/R'}{\ln t} ; \quad \Delta\gamma = \frac{1}{\ln t} \left(\frac{\Delta R}{R} + \frac{\Delta R'}{R'} \right) = \frac{1}{\ln 0.512} \left(\frac{0.01}{5.07} + \frac{0.01}{8.11} \right) = 0.00479 ; \quad \Delta\gamma = 0.01$$

Method B

$$\text{Higher value of } \gamma: \quad \gamma_{\max} = \ln \frac{R - \Delta R}{R' + \Delta R'} / \ln t = \ln \frac{5.07 - 0.01}{8.11 + 0.01} / \ln 0.512 = 0.70654$$

$$\text{Smaller value of } \gamma: \quad \gamma_{\min} = \ln \frac{R + \Delta R}{R' - \Delta R'} / \ln t = \ln \frac{5.07 + 0.01}{8.11 - 0.01} / \ln 0.512 = 0.69696$$

$$\Delta\gamma = \frac{\gamma_{\max} - \gamma_{\min}}{2} = \frac{0.70654 - 0.69696}{2} = 0.00479 ; \quad \Delta\gamma = 0.01$$

$R = 5.07 \text{ k}\Omega$	$\gamma = 0.70$
$R' = 8.11 \text{ k}\Omega$	$\Delta\gamma = 0.01$

c)

$$\text{We know that } R = c_3 e^{\frac{c_2\gamma}{\lambda_0 T}} \quad (3)$$

$$\text{then } \ln R = \ln c_3 + \frac{c_2\gamma}{\lambda_0 T}$$

$$\text{Because of } T = aR_B^{0.83} \quad (6)$$

$$\text{consequently } \ln R = \ln c_3 + \frac{c_2\gamma}{\lambda_0 a} R_B^{-0.83}$$

$$\ln R = \ln c_3 + \frac{c_2\gamma}{\lambda_0 a} R_B^{-0.83} \quad \text{Eq. (9)}$$

d)

V/V	I/mA	R_B/Ω	T/K	$R_B^{-0.83}$ (S.I.)	$R/\text{k}\Omega$	$\ln R$
9.48 ± 0.01	85.5 ± 0.1	110.9 ± 0.2	1962 ± 18	$(2.008 \pm 0.004)10^{-2}$	8.77 ± 0.01	2.171 ± 0.001
9.73 ± 0.01	86.8 ± 0.1	112.1 ± 0.2	1980 ± 18	$(1.990 \pm 0.004)10^{-2}$	8.11 ± 0.01	2.093 ± 0.001
9.83 ± 0.01	87.3 ± 0.1	112.6 ± 0.2	1987 ± 18	$(1.983 \pm 0.004)10^{-2}$	7.90 ± 0.01	2.067 ± 0.001
10.01 ± 0.01	88.2 ± 0.1	113.5 ± 0.2	2000 ± 18	$(1.970 \pm 0.004)10^{-2}$	7.49 ± 0.01	2.014 ± 0.001
10.25 ± 0.01	89.4 ± 0.1	114.7 ± 0.2	2018 ± 18	$(1.952 \pm 0.003)10^{-2}$	7.00 ± 0.01	1.946 ± 0.001
10.41 ± 0.01	90.2 ± 0.1	115.4 ± 0.2	2028 ± 18	$(1.943 \pm 0.003)10^{-2}$	6.67 ± 0.01	1.894 ± 0.002
10.61 ± 0.01	91.2 ± 0.1	116.3 ± 0.2	2041 ± 18	$(1.930 \pm 0.003)10^{-2}$	6.35 ± 0.01	1.849 ± 0.002
10.72 ± 0.01	91.8 ± 0.1	116.8 ± 0.2	2049 ± 19	$(1.923 \pm 0.003)10^{-2}$	6.16 ± 0.01	1.818 ± 0.002
10.82 ± 0.01	92.2 ± 0.1	117.4 ± 0.2	2057 ± 19	$(1.915 \pm 0.003)10^{-2}$	6.01 ± 0.01	1.793 ± 0.002
10.97 ± 0.01	93.0 ± 0.1	118.0 ± 0.2	2066 ± 19	$(1.907 \pm 0.003)10^{-2}$	5.77 ± 0.01	1.753 ± 0.002
11.03 ± 0.01	93.3 ± 0.1	118.2 ± 0.2	2069 ± 19	$(1.904 \pm 0.003)10^{-2}$	5.69 ± 0.01	1.739 ± 0.002
11.27 ± 0.01	94.5 ± 0.1	119.3 ± 0.2	2085 ± 19	$(1.890 \pm 0.003)10^{-2}$	5.35 ± 0.01	1.677 ± 0.002
11.42 ± 0.01	95.1 ± 0.1	120.1 ± 0.2	2096 ± 19	$(1.880 \pm 0.003)10^{-2}$	5.15 ± 0.01	1.639 ± 0.002
11.50 ± 0.01	95.5 ± 0.1	120.4 ± 0.2	2101 ± 19	$(1.875 \pm 0.003)10^{-2}$	5.07 ± 0.01	1.623 ± 0.002
			unnecessary			

We work out the errors for all the first row, as example.

$$\text{Error for } R_B: \Delta R_B = R_B \sqrt{\left(\frac{\Delta V}{V}\right)^2 + \left(\frac{\Delta I}{I}\right)^2} = 110.9 \sqrt{\left(\frac{0.01}{9.48}\right)^2 + \left(\frac{0.1}{85.5}\right)^2} = 0.2 \Omega$$

$$\text{Error for } T: \Delta T = T \left(\frac{\Delta a}{a} + 0.83 \frac{\Delta R_B}{R_B} \right); \Delta T = 1962 \left(\frac{0.3}{39.4} + 0.83 \frac{0.2}{110.9} \right) = 18 \text{ K}$$

Error for $R_B^{-0.83}$:

$$x = R_B^{-0.83}; \ln x = -0.83 \ln R_B; \Delta x = x \cdot 0.83 \frac{\Delta R_B}{R_B}; \Delta(R_B^{-0.83}) = R_B^{-0.83} \frac{\Delta R_B}{R_B}$$

$$\Delta(R_B^{-0.83}) = 0.020077 \frac{0.2}{110.9} \approx 0.004 \times 10^{-2}$$

$$\text{Error for } \ln R: \Delta \ln R = \frac{\Delta R}{R}; \Delta \ln R = \frac{0.01}{8.77} = 0.001$$

e)

We plot $\ln R$ versus $R_B^{-0.83}$.

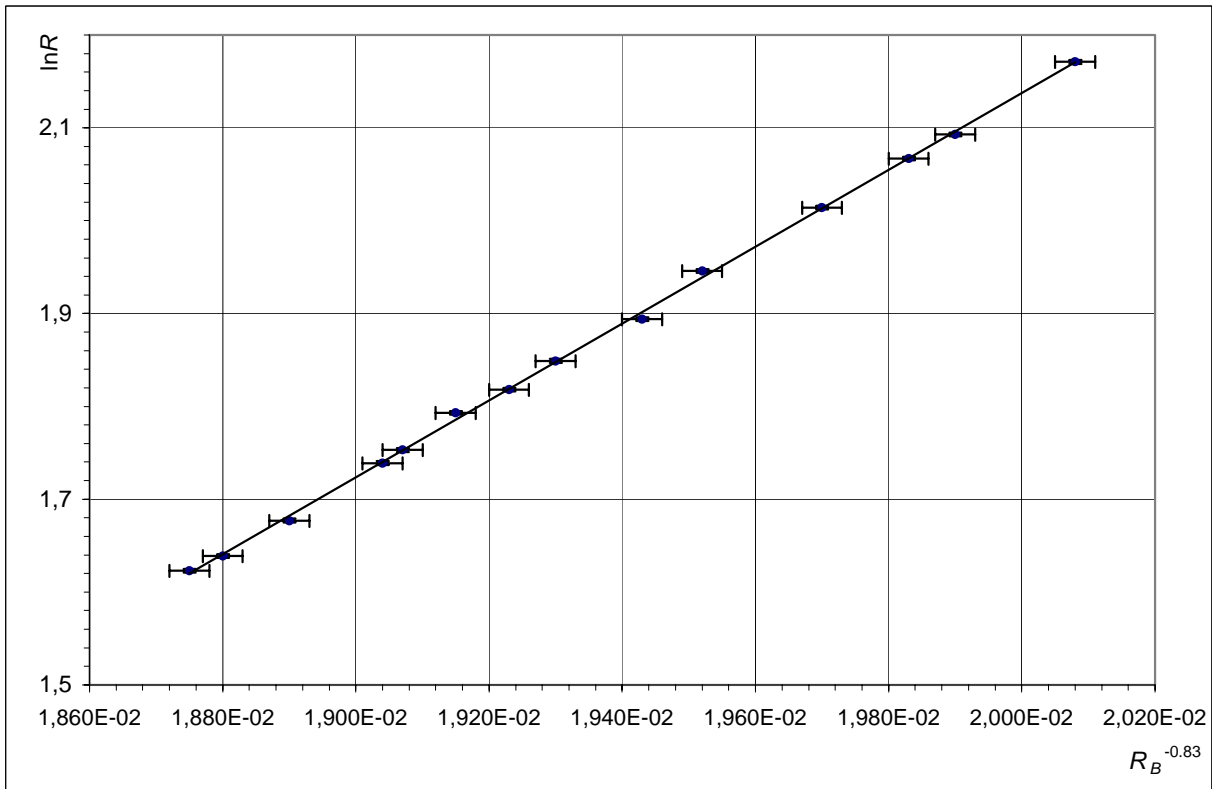

By the least squares

$$\text{Slope} = m = 414,6717$$

$$\sum (R_B^{-0.83})^2 = 5.23559 \times 10^{-3}$$

$$\sum (R_B^{-0.83}) = 0.27068$$

$$n = 14$$

$$\text{For axis } X: \sigma_{R_B^{-0.83}} = \frac{\sum \Delta(R_B^{-0.83})}{n} = 0.003 \times 10^{-2}$$

$$\text{For axis } Y: \sigma_{\ln R} = \frac{\sum \Delta(\ln R)}{n} = 0.002$$

$$\sigma = \sqrt{\sigma_{\ln R}^2 + m^2 \sigma_{R_B^{-0.83}}^2} = \sqrt{0.002^2 + 414.672^2 \cdot (0.003 \times 10^{-2})^2} = 0.0126$$

$$\Delta m = \sqrt{\frac{n \sigma^2}{n \sum (R_B^{-0.83})^2 - (\sum R_B^{-0.83})^2}} = \sqrt{\frac{14 \cdot 0,0126^2}{14 \cdot 5.23559 \times 10^{-3} - (0.27068)^2}} = 8.295$$

Because of

$$m = \frac{c_2 \gamma}{\lambda_0 a}$$

and

$$c_2 = \frac{hc}{k}$$

then

$$h = \frac{mk \lambda_0 a}{c \gamma}$$

$$h = \frac{414.67 \cdot 1.381 \times 10^{-23} \cdot 590 \times 10^{-9} \cdot 39.4}{2.998 \times 10^8 \cdot 0.70} = 6.35 \times 10^{-34}$$

$$\Delta h = h \sqrt{\left(\frac{\Delta m}{m}\right)^2 + \left(\frac{\Delta k}{k}\right)^2 + \left(\frac{\Delta \lambda_0}{\lambda_0}\right)^2 + \left(\frac{\Delta a}{a}\right)^2 + \left(\frac{\Delta \gamma}{\gamma}\right)^2}$$

$$\Delta h = 6.34 \times 10^{-34} \sqrt{\left(\frac{8.3}{415}\right)^2 + 0 + \left(\frac{28}{590}\right)^2 + \left(\frac{0.3}{39.4}\right)^2 + 0 + \left(\frac{0.01}{0.70}\right)^2} = 0.34 \times 10^{-34}$$

$h = 6.4 \times 10^{-34} \text{ J} \cdot \text{s}$	$\Delta h = 0.3 \times 10^{-34} \text{ J} \cdot \text{s}$
--	---